

# XPi series

## the *intelligent* pump

fixed displacement bent axis design



The compact size envelope of XPi pumps, together with their technology, means they can be installed in environments with little space available, and be used at relatively high rotating speeds.

### ADVANTAGES

- ▶ Pump automatically sets to required direction of rotation
- ▶ Mounting and start-up, easier than ever !

### CHARACTERISTICS

- 7 pistons
- original idea for plate - barrel synchronisation
- use of materials with high mechanical resistance
- reinforced sealing



#### ■ 10 models :

- from 12 to 130 cc/rev
- 380 bar continuous working pressure
- 420 bar peak pressure
- max. speed from 1750 to 3150 rpm

Pump reference	Displac. (cc/rev)	Maximum continuous pressure (bar)	Maximum intermittent peak pressure < 5 seconds (bar)	Maximum rotating speed at absolute pressure 1 bar with inlet line 2" (rpm)	Max. torque absorbed at 380 bar (N.m)	Weight		Overhang torque	
						without inlet fitting (kg)	with inlet fitting (kg)	without inlet fitting (N.m)	with inlet fitting (N.m)
XPi 12 0523820	12	380	420	3150	76	9.2	9.65	8.74	9.17
XPi 18 0523810	18	380	420	2900	114	9.25	9.7	8.79	9.21
XPi 25 0523800	25	380	420	2750	159	9.3	9.75	8.84	9.26
XPi 32 0523790	32	380	420	2700	204	11.1	11.55	11.1	11.55
XPi 41 0523780	41	380	420	2550	261	11.15	11.6	11.15	11.6
XPi 50 0523770	50.3	380	420	2450	318	11.2	11.65	11.76	12.23
XPi 63 0523760	63	380	420	2300	401	11.25	11.7	11.81	12.28
XPi 80 0523640	80.4	380	420	2150	509	14.85	15.3	17.82	18.36
XPi 108 0523750	108.3	380	420	1900	687	14.95	15.4	17.94	18.48
XPi 130 0523730	129.8	380	420	1750	827	15.35	15.8	18.73	19.28

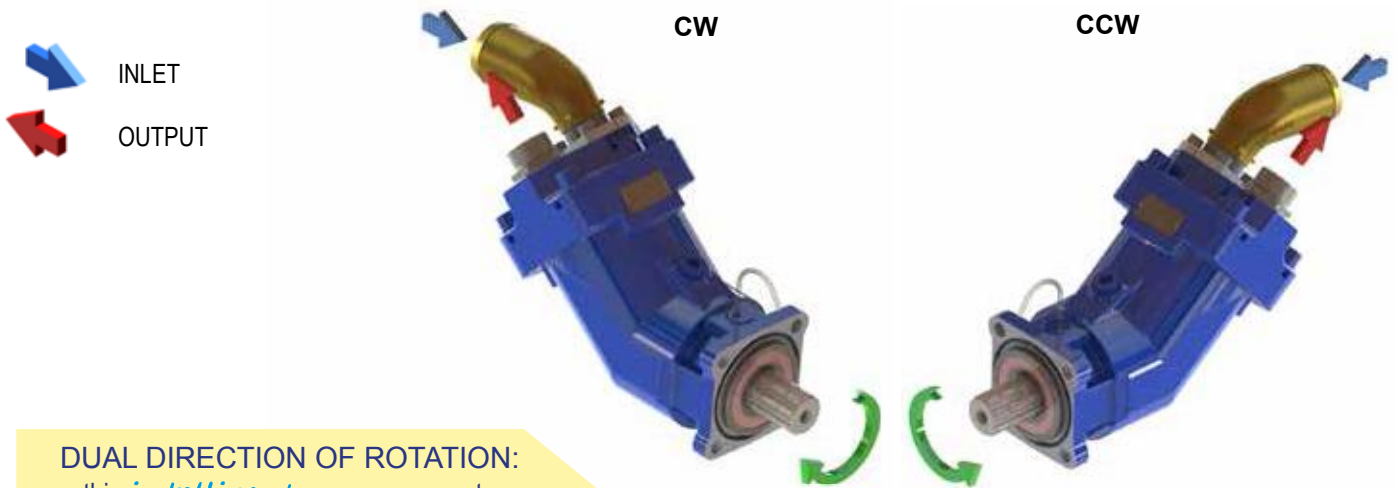

**DUAL DIRECTION OF ROTATION:**  
this *intelligent* pump can operate in either direction of rotation.

Fit the inlet fitting on required side, depending on the direction of rotation of the PTO, and the pump will set itself accordingly.

**When the PTO turns counter-clockwise, the pump has to turn clockwise.**

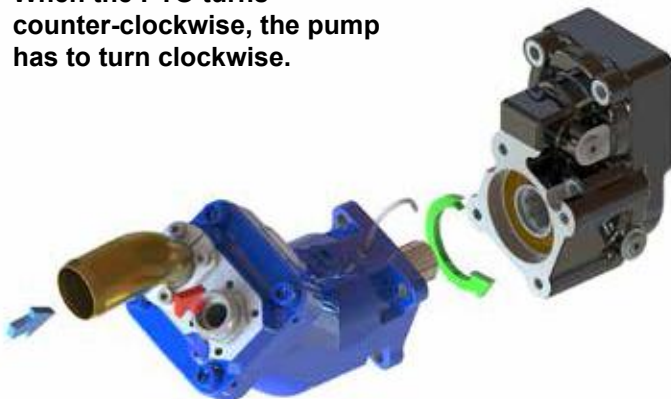

**When the PTO turns clockwise, the pump has to turn counter-clockwise.**



# XPi - Dimensions

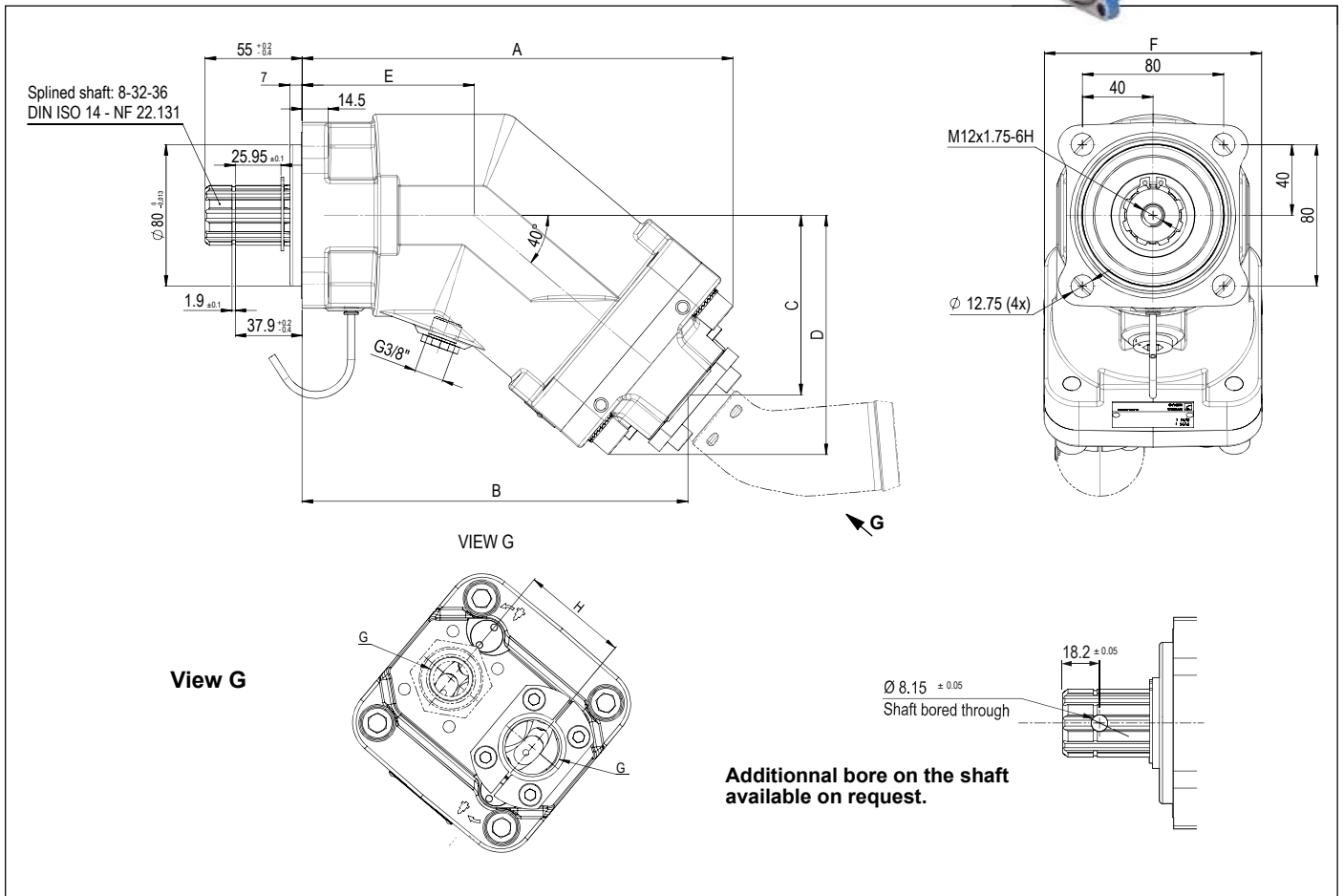

Pump reference	A	B	C	D	E	F	G	H
XPi 12 0523820	196.7	177.8	77.1	103.9	85.7	108	G 3/4"	54
XPi 18 0523810	196.7	177.8	77.1	103.9	85.7	108	G 3/4"	54
XPi 25 0523800	196.7	177.8	77.1	103.9	85.7	108	G 3/4"	54
XPi 32 0523790	202.8	184	82.3	109.1	85.7	108	G 3/4"	54
XPi 41 0523780	202.8	184	82.3	109.1	85.7	108	G 3/4"	54
XPi 50 0523770	214.4	195.6	92	118.9	85.7	108	G 3/4"	54
XPi 63 0523760	214.4	195.6	92	118.9	85.7	108	G 3/4"	54
XPi 80 0523640	241.7	220.9	103.5	133.3	97.4	123	G 1"	60
XPi 108 0523750	241.7	222.5	104.8	133.3	97.4	123	G 1"	60
XPi 130 0523730	244	224.8	106.7	135.2	97.4	123	G 1"	60

Dimensions in mm.

## ► Torque absorbed as a function of pump output pressure

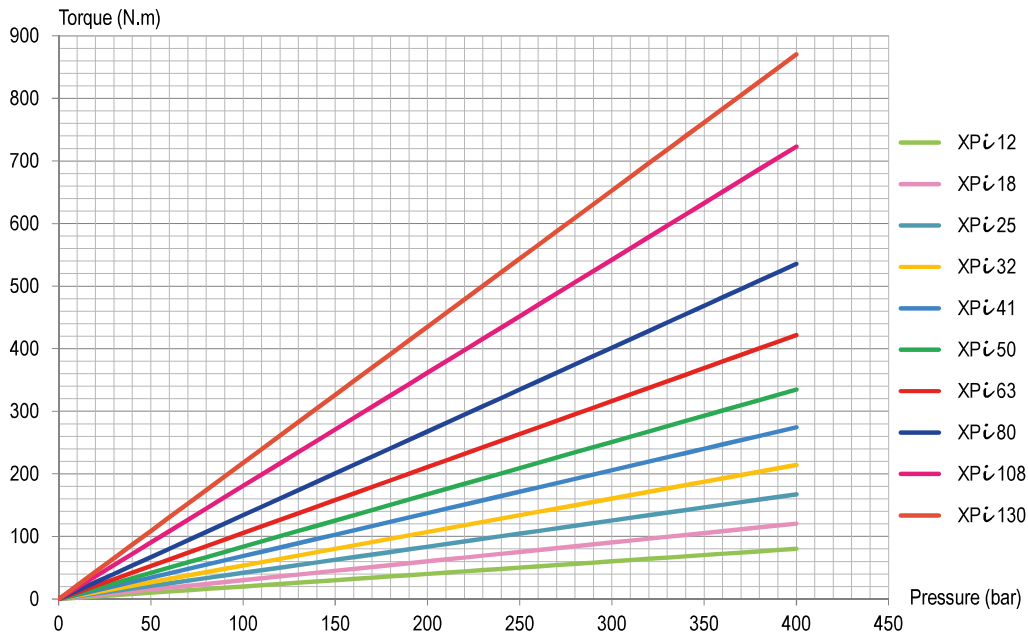

## ► Flow as a function of rotating speed

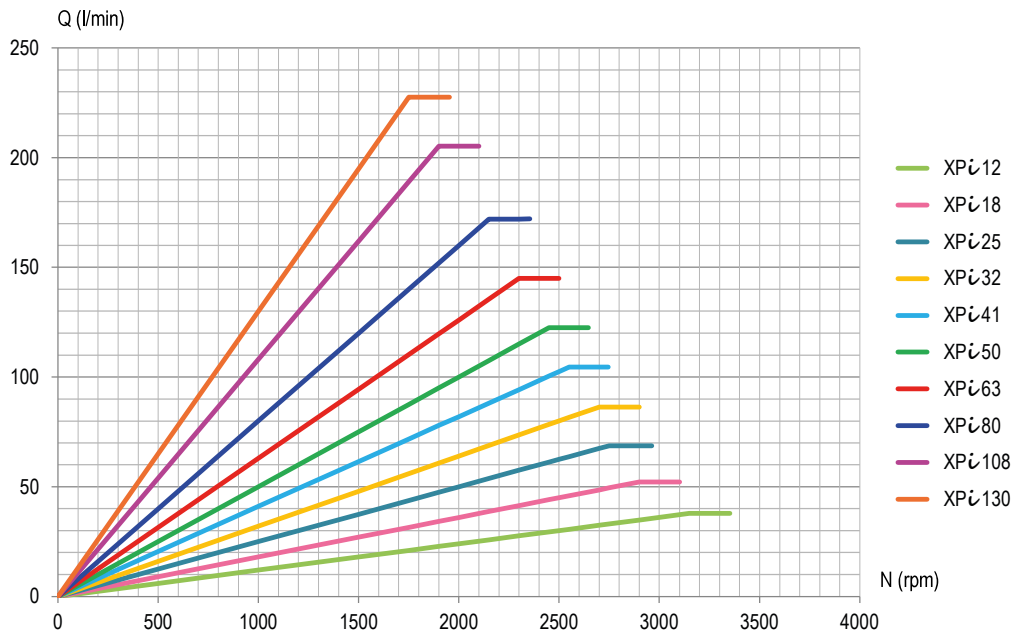

## ► Volumetric efficiency

These graphs are the results of testwork done in HL R&D laboratory, on a specific test bench, with an ISO 46 fluid at 77°F/25°C (100 cSt), the pump is fitted with a 2" inner diameter HL inlet fitting, and tank situated slightly above pump.

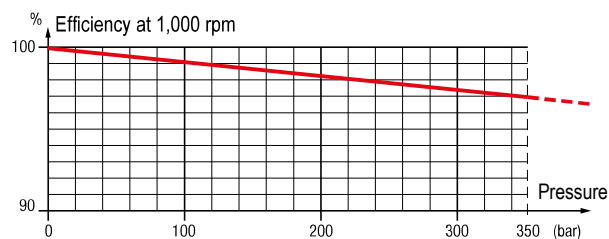

# XPi - Accessories



## INLET FITTINGS FOR XPi PUMPS

See recommendations of the hosing dimensions on page 38.

All XPi pumps are supplied with their inlet fitting.  
Please specify required fitting from the choice below when ordering.

### 45° elbow fittings

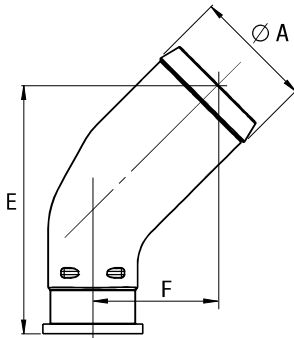

Reference	Ø hose	Ø A	E	F
0517894	1 1/2"	39.1	91.7	46.7
0517896	42	43	91.7	46.7
0517897	1 3/4"	46	91.7	46.7
0517893	2"	51.8	108.4	54.4
0517892	2 1/2"	64.5	125.2	62.2

Dimensions in mm.

### 90° elbow fittings

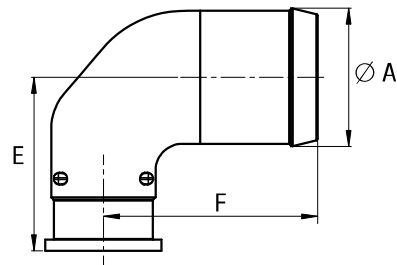

Reference	Ø hose	Ø A	E	F
0517947	1 1/2"	39.1	58.6	79.5
0517946	2"	51.8	64.9	80.2
0517945	2 1/2"	64.5	71.3	87.5

Dimensions in mm.

## DEFLECTOR TO PROTECT SHAFT SEALS

This deflector ensures the protection of the pump shaft seals.  
In particular, it protects the pump from projections of dirt from the road in cardan drive installations.

Reference: **DEF 054111**

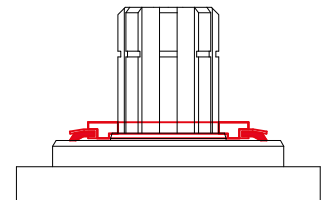

## BY-PASS VALVE FOR XPi PUMPS

For XPi pump applications where the pump is driven by a continuous running PTO (PTO which cannot be disengaged), HYDRO LEDUC offers a by-pass valve which is fitted onto the back of the pump.

This solution allows the continuous running of the pump:

- without creating problems of fluid overheating;
- without affecting pump service life;
- with no modifications necessary to the hydraulic circuit of the equipment.

LEDUC part number	12 Volts	24 Volts
XPi 12 to XPi 63	BP63 0521180	BP63 0517931
XPi 80 to XPi 130	BP80 0522235	BP80 0522140

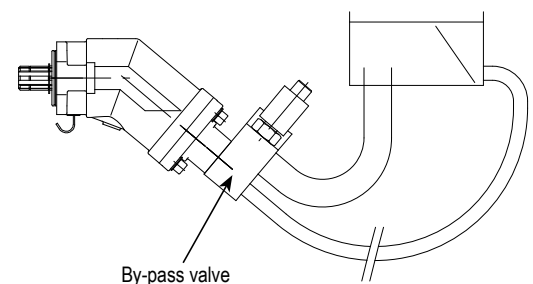

## ► How does it work ?

The by-pass valve is a 12 or 24 Volts solenoid valve.

When not activated, it enables pump output to link up to pump inlet.  
When it is activated, the pump operates normally (output flow).

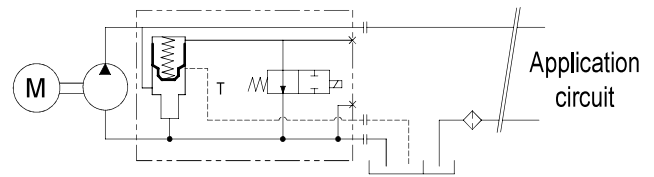

If the valve in your circuit limits the oil return to the tank to less than 5l /mn or if the distributor is “closed-center”, a drain line has to be installed between the By-Pass valve and the tank to assure sufficient oil circulation to avoid the pump overheating.

## ► XPi overhang torque with by-pass

Pump reference	Weight		Overhang torque	
	without inlet fitting (kg)	with inlet fitting (kg)	without inlet fitting (N.m)	with inlet fitting (N.m)
XPi 12	12.8	13.25	16.32	16.90
XPi 18	12.85	13.3	16.39	16.96
XPi 25	12.9	13.35	16.44	17.02
XPi 32	14.7	15.15	18.98	19.56
XPi 41	14.75	15.2	19.04	19.62
XPi 50	14.8	15.25	20.05	20.67
XPi 63	14.85	15.3	20.12	20.73
XPi 80	18.45	18.9	27.16	27.82
XPi 108	18.55	19	27.31	27.97
XPi 130	18.95	19.4	28.16	28.93

## ► Dimensions with by-pass valve

Pump reference	A	B	C	D	E	F	G	H	J
XPi 12 / 18 / 25	289.35	223.04	202.19	132.20	114.72	97.58	3/4"	54	108
XPi 32 / 41	295.5	229	208.3	137.3	120.1	102.7	3/4"	54	108
XPi 50 / 63	307.1	240.4	220	147.1	129.7	112.5	3/4"	54	108
XPi 80 / 108	334	269	246.7	157.8	143.9	124.8	1"	60	123
XPi 130	336.3	271.3	249	159.7	145.8	126.7	1"	60	123.5

Dimensions in mm.

